

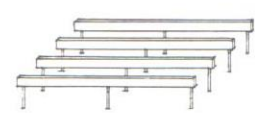







<p>3.1.1</p> 	<p>3.1.2</p> <ol style="list-style-type: none">1 2 3 	<p>3.1.3</p> <ol style="list-style-type: none">1 4 	<p>3.1.4</p> <ol style="list-style-type: none">1 2 
<p>3.2.1</p> 	<p>3.2.2</p> <ol style="list-style-type: none">1 2 3 	<p>3.2.3</p> <ol style="list-style-type: none">1 2 	<ol style="list-style-type: none">3 
<p>3.3.1</p> 	<p>3.3.2</p> <ol style="list-style-type: none">1 2 3 	<p>3.3.3</p> <ol style="list-style-type: none">1 2 	<p>3.3.4</p> <ol style="list-style-type: none">→→
<p>3.4.1</p> 	<p>3.4.2</p> <ol style="list-style-type: none">1 2 3 	<p>3.4.3</p> <ol style="list-style-type: none">1 2 3 	<p>3.4.4</p> <ol style="list-style-type: none">1 2 

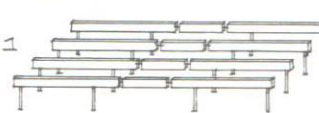
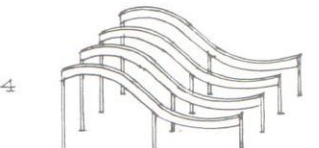
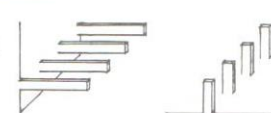
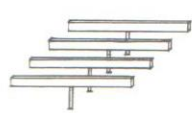
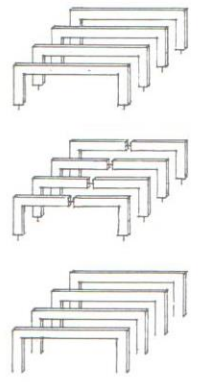
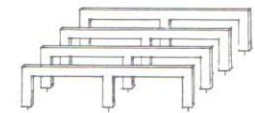
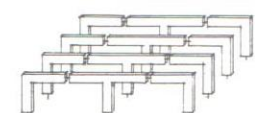
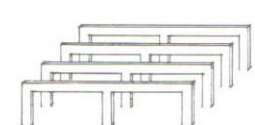

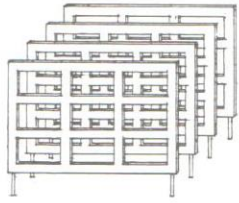
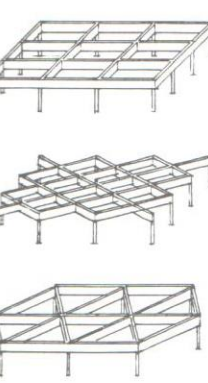
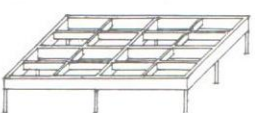
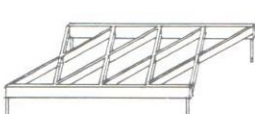
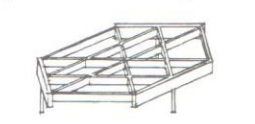
5.1.1

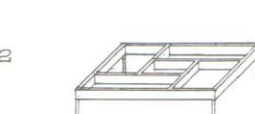
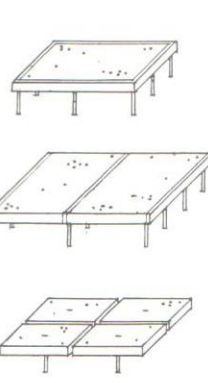
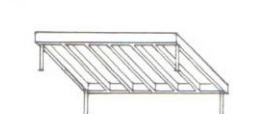
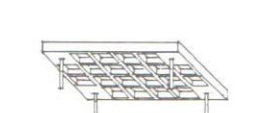
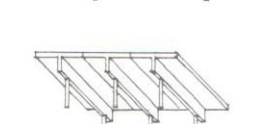
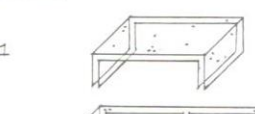
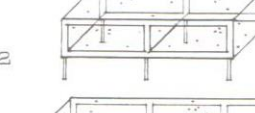

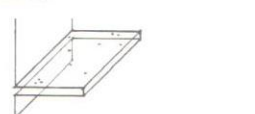
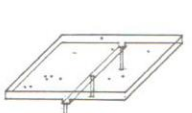
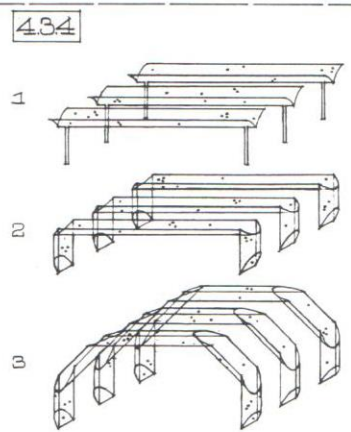
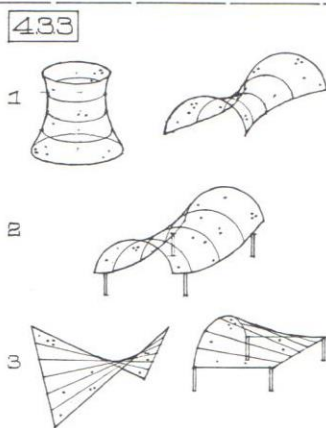
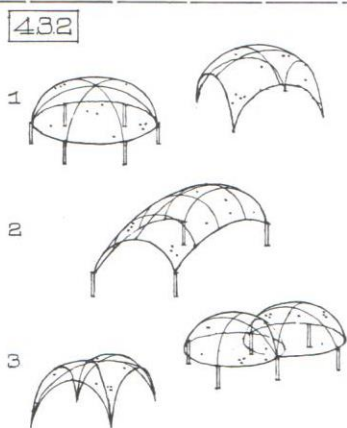
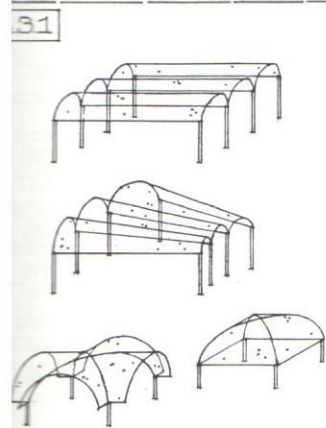
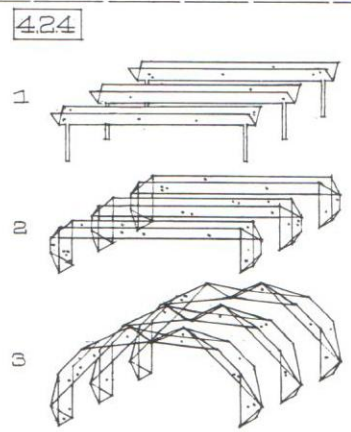
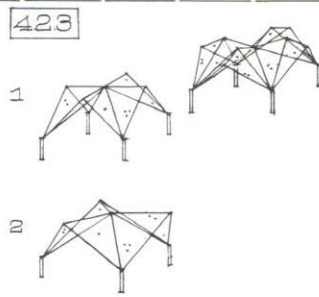
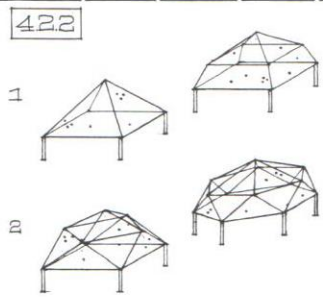
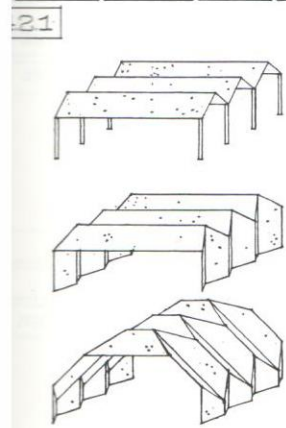
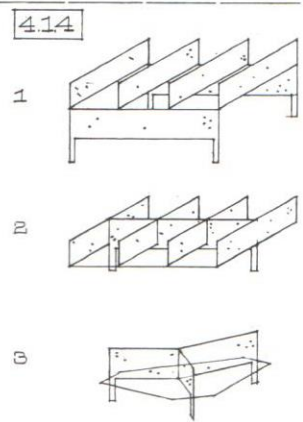
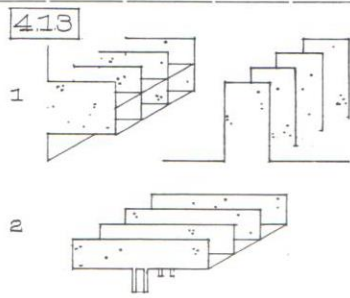
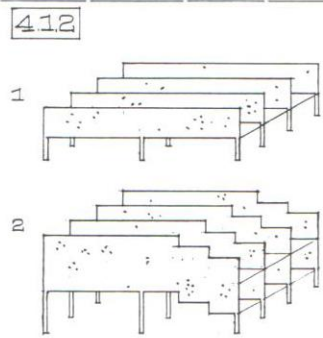
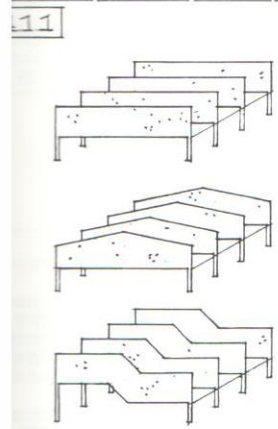
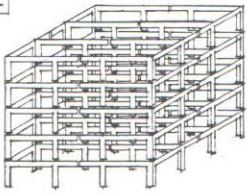
5.1.2

1

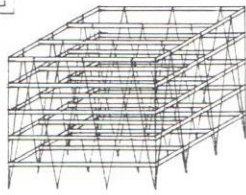

2

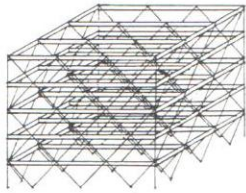

5.1.3

1

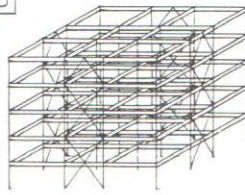

2

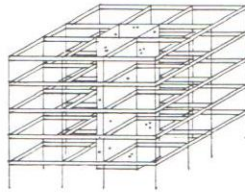

5.1.4

1

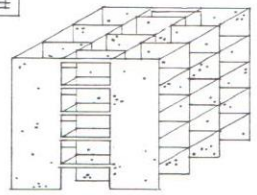

2

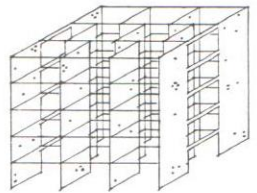

5.2.1

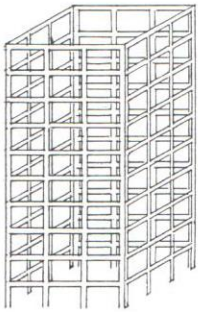

5.2.2

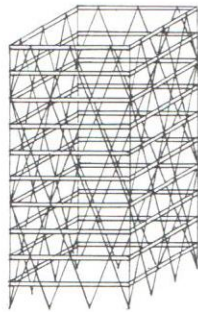

5.2.3

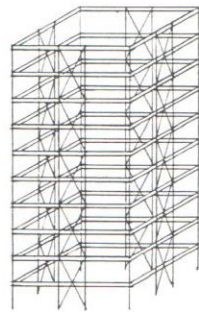

5.2.4

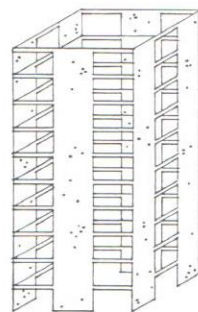

5.3.1

2

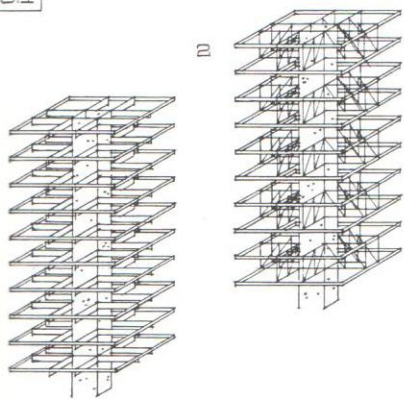

5.3.2

1

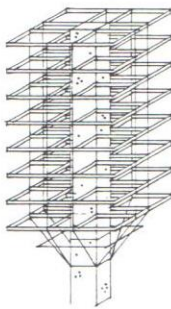

2

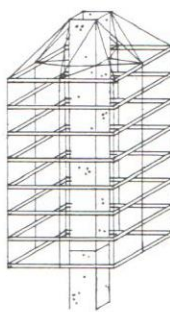

3

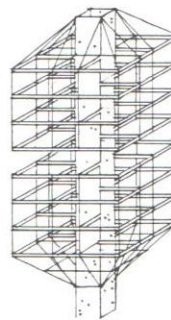

5.4.1

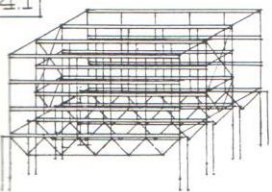

5.4.2

1

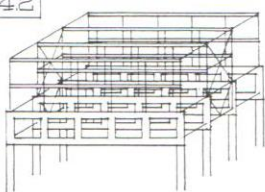

2

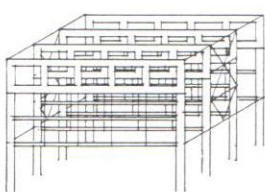

3

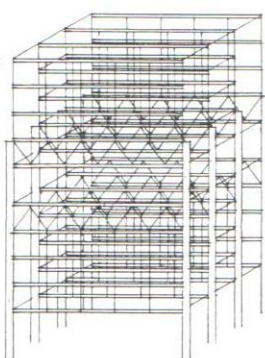

5.4.3

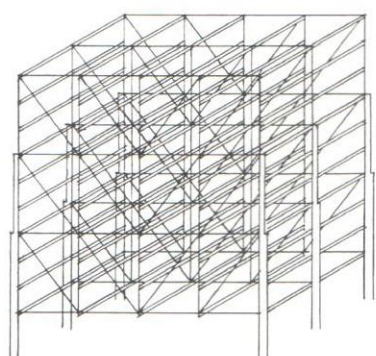

2.1 Ebene Fachwerkbinder / Flat trusses

Obergurt-Systeme
Top chord systems

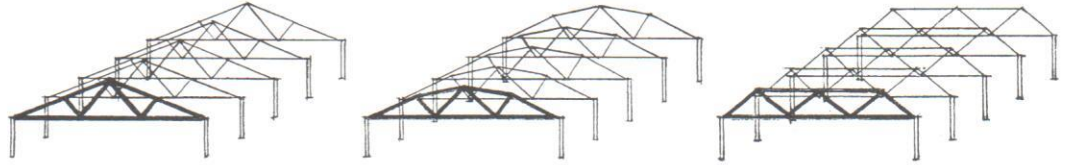

Untergurt-Systeme
Bottom chord systems

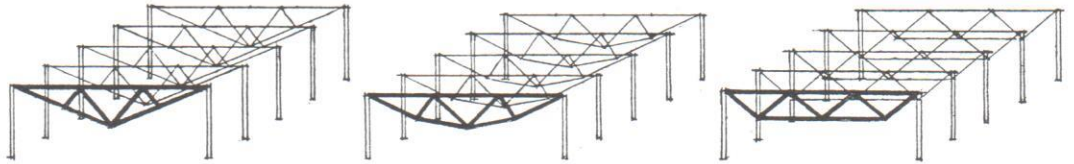

Zweigurt-Systeme
Two-chord systems

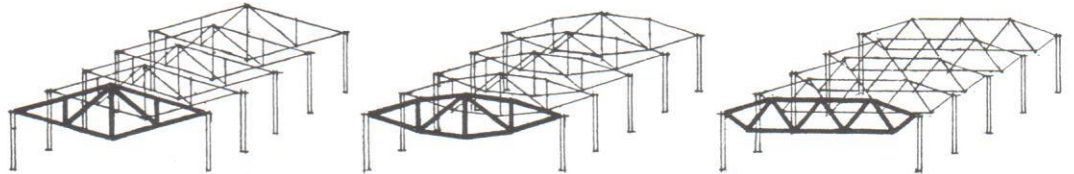

Überhöhte Systeme
Cambered systems

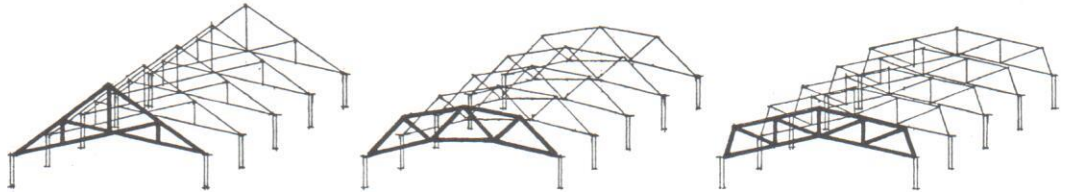

2.2 Übertragene ebene Fachwerke / Transmitted flat trusses

Lineare Systeme
Linear systems

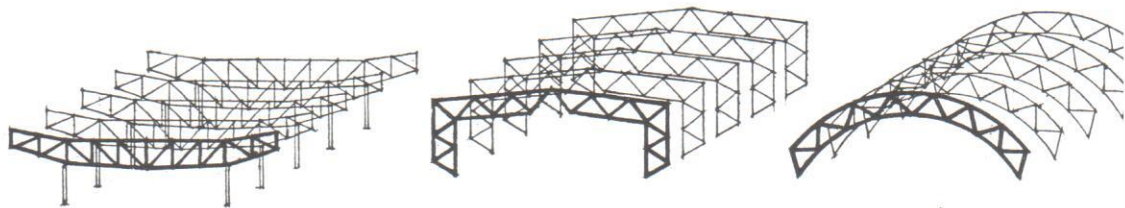

Gefaltete Systeme
Folded systems

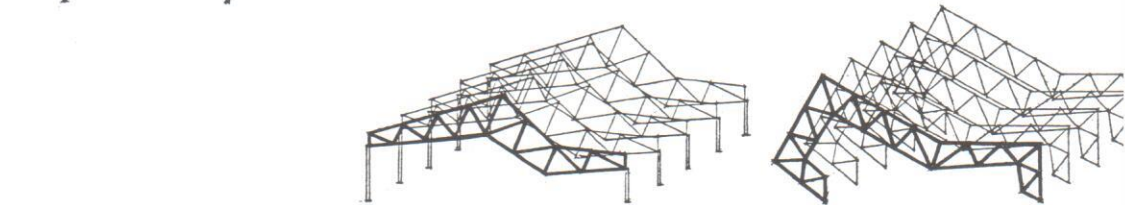

Durchdringungs-Systeme
Intersecting systems

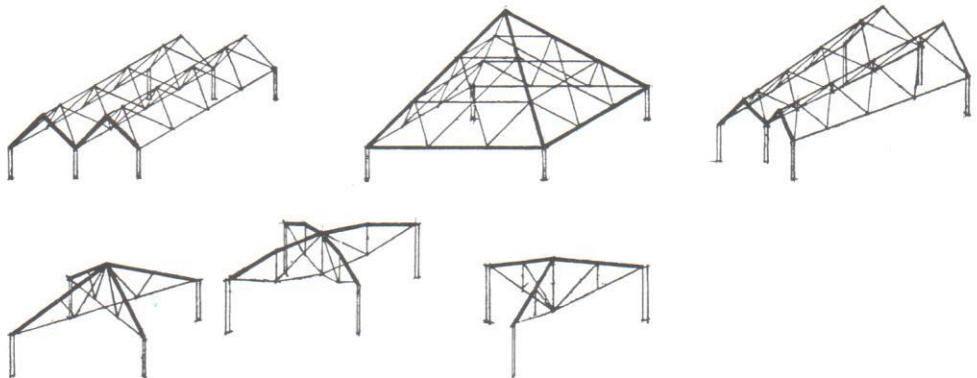

Anwendungen = Tragsystem - Baustoff - Spannweite

Applications = structure system - material - span

Tragsystem / Structure system		Primär-Baustoff / Primary material	Spannweiten in Metern / Spans in meters																	
			0	5	10	15	20	25	30	40	50	60	80	100	150	200	250	300	400	
Ebene Fachwerke 2.1 Flat trusses		Holz / wood Metall (Stahl) / metal (steel)			8	15	20	30	40											
		Holz / wood Metall (Stahl) / metal (steel)			10	20	30	40	50	60										
		Holz / wood Metall (Stahl) / metal (steel)			10	20	30	40	50	60	80	100								
Ungesetzte ebene Fachwerke 2.2 Transmitted flat trusses		Holz / wood Metall (Stahl) / metal (steel)			8	12	25	30												
		Holz / wood Metall (Stahl) / metal (steel)			10	20	30	40	50	60	80	100	120							
		Holz / wood Metall (Stahl) / metal (steel)			8	15	25	35	45											
Gekrümmte Fachwerke 2.3 Curved trusses		Holz / wood Metall (Stahl) / metal (steel)			8	12	25	30												
		Holz / wood Metall (Stahl) / metal (steel)			10	20	30	40	50	60	80	100	120							
		Holz / wood Metall (Stahl) / metal (steel)			20	40	60	80	100	120	150	200	250	300	400					
Raum-fachwerke 2.4 Space trusses		Holz / wood Metall (Stahl) / metal (steel)			8	15	25	35	45	60	80	100	120							
		Holz / wood Metall (Stahl) / metal (steel)			6	15	25	35	45	60	80	100	120							
		Holz / wood Metall (Stahl) / metal (steel)			15	25	40	50	60	70	80	100	120	150						

Jeden Tragwerk-Typ ist ein spezifischer Spannungszustand seiner Tragglieder zu eigen. Hieraus ergeben sich für den Entwurf zwangsläufige Bindungen in der Wahl des Primär-Baustoffes und in der Zuordnung von Spannweiten

To each structure type a specific stress condition of its members is inherent. This essential trait conditions the design of structures to rational affiliations: the choice of primary structural fabric and in the attribution of span capacity

Gestaltungsmöglichkeiten durch Dachflächendifferenzierung bei durchlaufenden Fachwerkträgern
design possibilities through differentiation of roof planes in continuous trusses

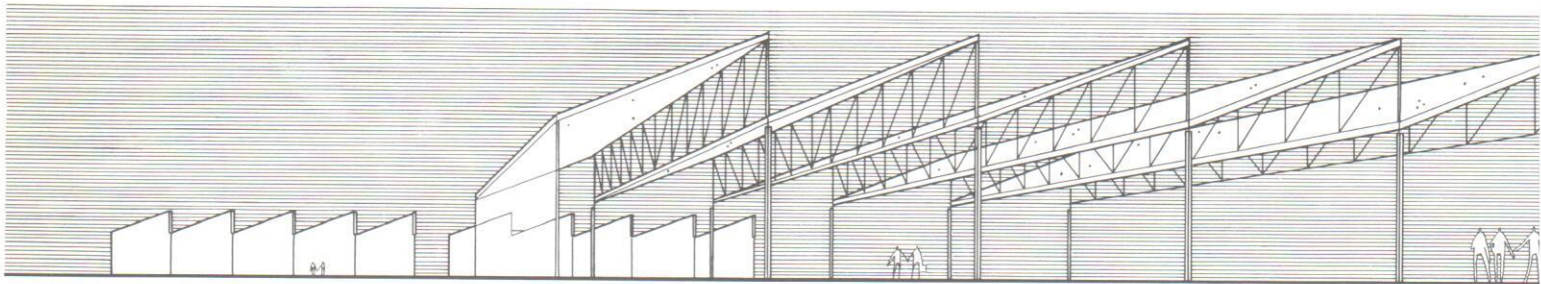

Geneigte Dachflächen beidseitig unterstützt

inclined roof planes with both ends sup

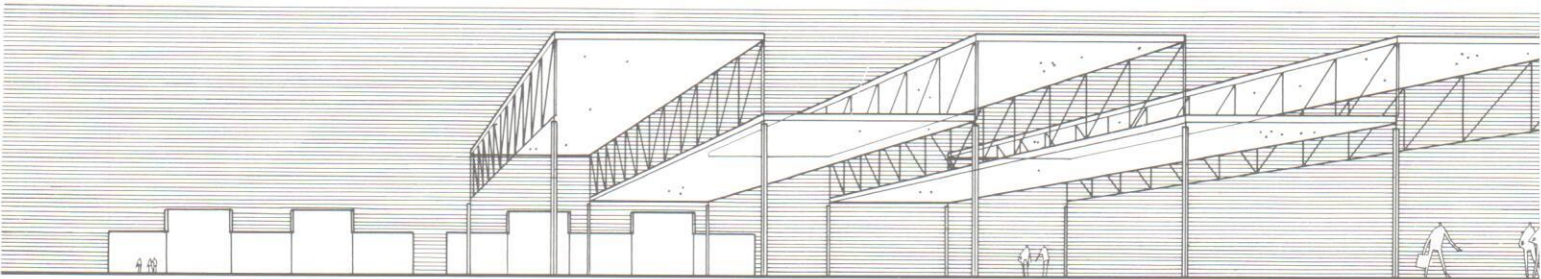

Abwechselnde horizontale Dachflächen beidseitig unterstützt

alternating horizontal roof planes with both ends sup

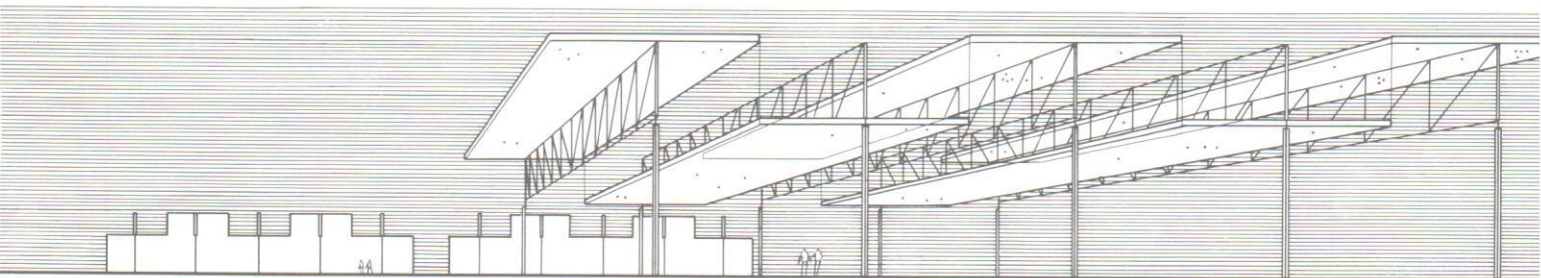

Abwechselnde horizontale Dachflächen mittig unterstützt

alternating horizontal roof planes centrally sup

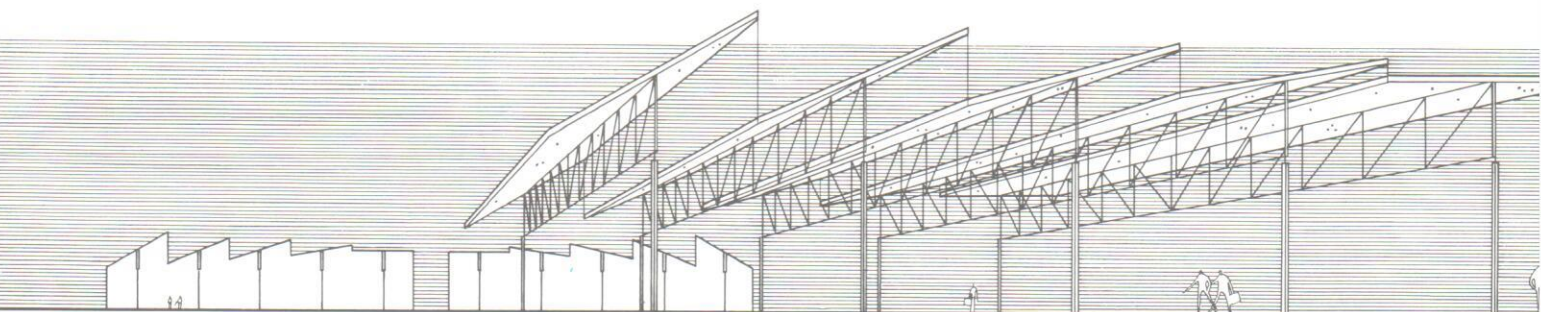

Dachflächen mit unterschiedlicher Neigung mittig unterstützt

roof planes with differing inclination centrally sup

Anwendungen = Tragsystem - Baustoff - Spannweite

Applications = structure system - material - s

Tragsystem / Structure system		Primär-Baustoff / Primary material	Spannweiten in Metern / Spans in meters																			
			0	5	10	15	20	25	30	40	50	60	80	100	150	200	250	300	400			
BALKEN- Tragwerke 3.1 BEAM structures		Holz / wood			4	8	12															
		Metall (Stahl) / metal (steel)		5	7	20	25															
		Stahlbeton / reinf. concrete		4	10	15																
		Leimholz / glued wood			7	10	30	35														
		Metall (Stahl) / metal (steel)		5	8	25	30															
		Spannbeton / stressed concn.		7	10	25	30															
		Holz / wood			4	8	12															
		Metall (Stahl) / metal (steel)		5	7	20	25															
		Stahlbeton / reinf. concrete		4	8	12																
RAHMEN- Tragwerke 3.2 FRAME structures		Leimholz / glued wood				10	15	40	50													
		Metall (Stahl) / metal (steel)			10	15	60	80														
		Stahlbeton / reinf. concrete		7	10	25	30															
		Leimholz / glued wood			10	15	45	55														
		Metall (Stahl) / metal (steel)			10	15	65	85														
		Stahlbeton / reinf. concrete		8	10	28	35															
		Leimholz / glued wood			15	20	50	60														
		Metall (Stahl) / metal (steel)			15	20	70	90														
		Stahlbeton / reinf. concrete			10	15	30	40														
BALKENROST- Tragwerke 3.3 BEAM GRID structures		Leimholz / glued wood			10	12	25	30														
		Metall (Stahl) / metal (steel)			10	12	25	30														
		Stahlbeton / reinf. concrete		5	8	18	20															
		Leimholz / glued wood			10	15	30	35														
		Metall (Stahl) / metal (steel)			10	15	30	35														
		Stahlbeton / reinf. concrete		5	8	20	25															
		Leimholz / glued wood			8	10	20	25														
		Stahlbeton / reinf. concrete			5	8	15	18														
PLATTEN- Tragwerke 3.4 SLAB structures		Holz (-bohlen) / wood (planks)		0	5	8																
		Stahlbeton / reinf. concrete		0	6	8																
		Stahlbeton / reinf. concrete		5	7	15	20															
		Stahlbeton / reinf. concrete		5	4	9	12															

Jeden Tragwerk-Typ ist ein spezifischer Spannungszustand seiner Tragglieder zu eigen. Hieraus ergeben sich für den Entwurf zwangsläufige Bindungen in der Wahl des Primär-Baustoffes und in der Zuordnung von Spannweiten

To each structure type a specific stress condition of its members is inherent. This essential trait submits the design of structures to rational affiliations: the choice of primary structural fabric and in the attribution of span capacity.

Querschnitt-Gestaltung der Vollwand-Träger

Section design of solid web beams

Wirkungsweise der schnittaktiven Tragsysteme beruht auf Mobilisierung Schnittkräften. Das heißt, die Tragfunktion dieser Systeme wird durch Kräfte im Querschnitt ausgelöst. Folgerichtig ist hier – im Unterschied zu den anderen Tragwerk-Gattungen – die Ausbildung des Träger-QUERSCHNITTES unabhängig von Material ein primäres Anliegen des Tragwerk-Entwurfs

The mechanics of section-active structure systems rests upon mobilization of section forces. This will say that the structural function of these systems is performed by actions within the cross section. Consequently, the design of the beam CROSS SECTION, in compliance with the specific material, is – unlike as with other structure families – a primary concern in developing structures

1 / Wood

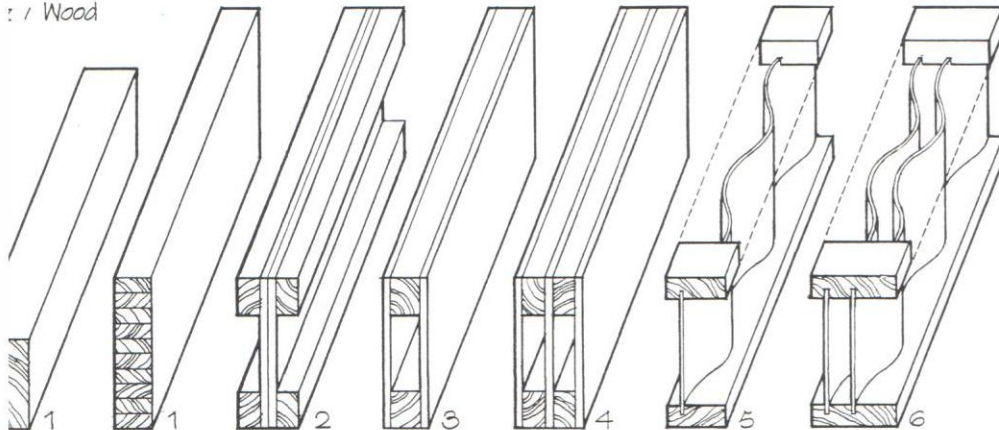

- 1 Rechteck-Träger
 - 2 I-Träger
 - 3 Kasten-Träger
 - 4 Doppelkasten-Träger
 - 5 Wellsteg-Träger
 - 6 Doppelwellsteg-Träger
-
- 1 Rectangular beam
 - 2 I-beam
 - 3 Box beam
 - 4 Double-box beam
 - 5 Corrugated web beam
 - 6 Corrug, two-web beam

2 / Steel

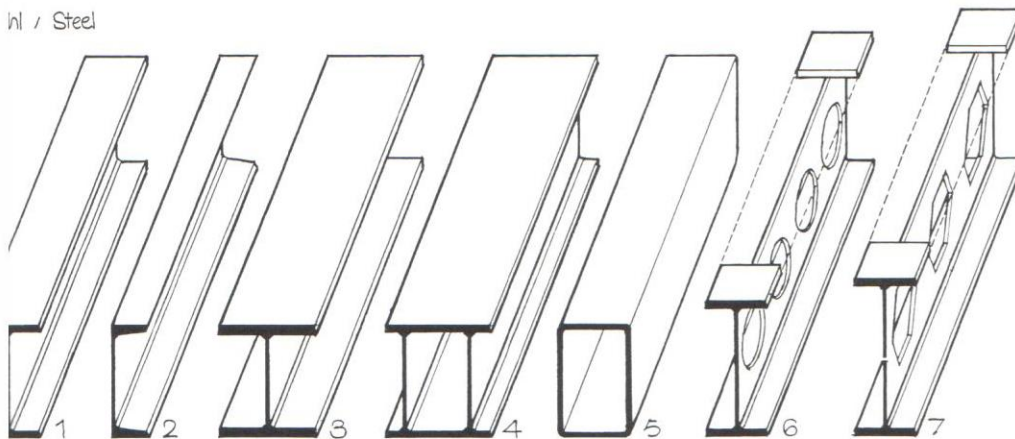

- 1 I-Träger
 - 2 U-Profil-Träger
 - 3 Breitflansch-Träger
 - 4 Kasten-Träger
 - 5 Hohlprofil-Träger
 - 6 Lochsteg-Träger
 - 7 Waben-Träger
-
- 1 I beam
 - 2 Channel (profile) beam
 - 3 Wide flange I, H beam
 - 4 Box beam
 - 5 Hollow section beam
 - 6 Perforated web beam
 - 7 Honeycomb web beam

3 / Beton / Reinforced concrete

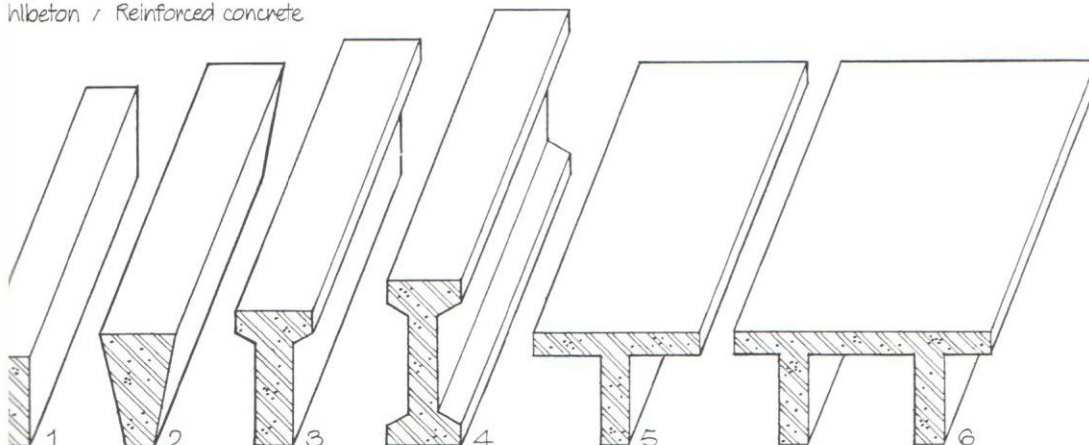

- 1 Rechteck-Träger
 - 2 Trapez-Träger
 - 3 T-Träger
 - 4 I-Träger
 - 5 Plattenbalken
 - 6 Doppelsteg-Plattenbalken
-
- 1 Rectangular beam
 - 2 Trapezoid beam
 - 3 Top-beaded beam
 - 4 I beam
 - 5 T beam
 - 6 Double-T beam

Neben den Standard-Trägerquerschnitten, die durch die Eigenschaften des Baustoffes mitbestimmt werden, führt die Kombination von Baustoffen unter Ausnutzung der konstruktiven Vorzüge des eingesetzten Materials zu neuen, anders leistungsfähigen Querschnitt-Formen = VERBUNDTRÄGER

In addition to the standard forms of beam sections, largely being determined by the properties of but one structural material, the combination of materials, through the utilization of their respective structural merits, will lead to novel, especially efficient cross sections = COMPOSITE BEAMS



1967

1997